

3 Phase bridge NPT IGBT Power Module

$V_{CES} = 600V$
 $I_C = 50A^* @ T_c = 80^\circ C$

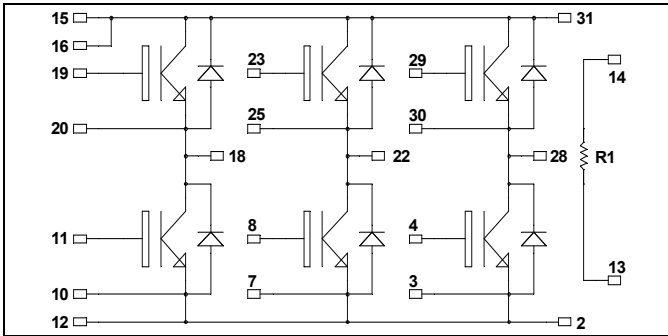

It is recommended to connect a decoupling capacitor between pins 31 & 2 to reduce switching overvoltages, if DC Power is connected between pins 15, 16 & 12. Pins 15 & 16 must be shorted together.

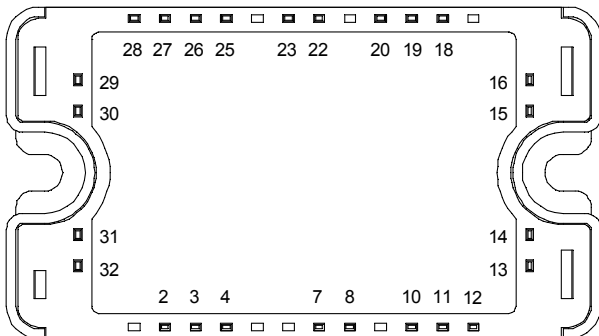

Application

- Motor control

Features

- Non Punch Through (NPT) Fast IGBT
 - Low voltage drop
 - Low tail current
 - Switching frequency up to 100 kHz
 - Soft recovery parallel diodes
 - Low diode VF
 - Low leakage current
 - RBSOA and SCSOA rated
- Kelvin emitter for easy drive
- Very low stray inductance
- High level of integration
- Internal thermistor for temperature monitoring

Benefits

- Outstanding performance at high frequency operation
- Direct mounting to heatsink (isolated package)
- Low junction to case thermal resistance
- Solderable terminals both for power and signal for easy PCB mounting
- Low profile
- RoHS compliant

Absolute maximum ratings

Symbol	Parameter	Max ratings	Unit
V_{CES}	Collector - Emitter Breakdown Voltage	600	V
I_C	Continuous Collector Current	$T_C = 25^\circ C$	65
		$T_C = 80^\circ C$	50 *
I_{CM}	Pulsed Collector Current	$T_C = 25^\circ C$	230
V_{GE}	Gate - Emitter Voltage	± 20	V
P_D	Maximum Power Dissipation	$T_C = 25^\circ C$	250
RBSOA	Reverse Bias Safe Operating Area	$T_j = 125^\circ C$	100A @ 500V

* Specification of IGBT device but output current must be limited to 40A at $T_c=80^\circ C$ not to exceed a connectors temperature greater than $120^\circ C$.

CAUTION: These Devices are sensitive to Electrostatic Discharge. Proper Handling Procedures Should Be Followed. See application note APT0502 on www.microsemi.com

All ratings @ $T_j = 25^\circ\text{C}$ unless otherwise specified

Electrical Characteristics

Symbol	Characteristic	Test Conditions	Min	Typ	Max	Unit	
I_{CES}	Zero Gate Voltage Collector Current	$V_{GE} = 0\text{V}$ $V_{CE} = 600\text{V}$	$T_j = 25^\circ\text{C}$		250	μA	
			$T_j = 125^\circ\text{C}$		500		
$V_{CE(sat)}$	Collector Emitter Saturation Voltage	$V_{GE} = 15\text{V}$ $I_C = 50\text{A}$	$T_j = 25^\circ\text{C}$	1.7	2.0	2.45	V
			$T_j = 125^\circ\text{C}$		2.2		
$V_{GE(th)}$	Gate Threshold Voltage	$V_{GE} = V_{CE}, I_C = 1\text{mA}$		4		6	V
I_{GES}	Gate – Emitter Leakage Current	$V_{GE} = 20\text{V}, V_{CE} = 0\text{V}$			400	nA	

Dynamic Characteristics

Symbol	Characteristic	Test Conditions	Min	Typ	Max	Unit
C_{ies}	Input Capacitance	$V_{GE} = 0\text{V}$		2200		pF
C_{oes}	Output Capacitance	$V_{CE} = 25\text{V}$		323		
C_{res}	Reverse Transfer Capacitance	$f = 1\text{MHz}$		200		
Q_g	Total gate Charge	$V_{GE} = 15\text{V}$		166		nC
Q_{ge}	Gate – Emitter Charge	$V_{Bus} = 300\text{V}$		20		
Q_{gc}	Gate – Collector Charge	$I_C = 50\text{A}$		100		
$T_{d(on)}$	Turn-on Delay Time	Inductive Switching (25°C)		40		ns
T_r	Rise Time	$V_{GE} = 15\text{V}$		9		
$T_{d(off)}$	Turn-off Delay Time	$V_{Bus} = 400\text{V}$ $I_C = 50\text{A}$		120		
T_f	Fall Time	$R_G = 2.7\Omega$		12		
$T_{d(on)}$	Turn-on Delay Time	Inductive Switching (125°C)		42		ns
T_r	Rise Time	$V_{GE} = 15\text{V}$		10		
$T_{d(off)}$	Turn-off Delay Time	$V_{Bus} = 400\text{V}$ $I_C = 50\text{A}$		130		
T_f	Fall Time	$R_G = 2.7\Omega$		21		
E_{on}	Turn-on Switching Energy	$V_{GE} = 15\text{V}$ $V_{Bus} = 400\text{V}$	$T_j = 125^\circ\text{C}$		0.5	mJ
E_{off}	Turn-off Switching Energy	$I_C = 50\text{A}$ $R_G = 2.7\Omega$	$T_j = 125^\circ\text{C}$		1	

Reverse diode ratings and characteristics

Symbol	Characteristic	Test Conditions	Min	Typ	Max	Unit
V_{RRM}	Maximum Peak Repetitive Reverse Voltage		600			V
I_{RM}	Maximum Reverse Leakage Current	$V_R = 600\text{V}$	$T_j = 25^\circ\text{C}$		25	μA
			$T_j = 125^\circ\text{C}$		500	
I_F	DC Forward Current			30		A
V_F	Diode Forward Voltage	$I_F = 30\text{A}$		1.8	2.2	V
		$I_F = 60\text{A}$		2.2		
		$I_F = 30\text{A}$	$T_j = 125^\circ\text{C}$	1.5		
t_{rr}	Reverse Recovery Time	$I_F = 30\text{A}$	$T_j = 25^\circ\text{C}$	25		ns
		$V_R = 400\text{V}$	$T_j = 125^\circ\text{C}$	160		
Q_{rr}	Reverse Recovery Charge	$di/dt = 200\text{A}/\mu\text{s}$	$T_j = 25^\circ\text{C}$	35		nC
			$T_j = 125^\circ\text{C}$	480		

Temperature sensor NTC (see application note APT0406 on www.microsemi.com for more information).

Symbol	Characteristic	Min	Typ	Max	Unit
R ₂₅	Resistance @ 25°C		50		kΩ
B _{25/85}	T ₂₅ = 298.15 K		3952		K

$$R_T = \frac{R_{25}}{\exp\left[B_{25/85}\left(\frac{1}{T_{25}} - \frac{1}{T}\right)\right]}$$

T: Thermistor temperature
 R_T: Thermistor value at T

Thermal and package characteristics

Symbol	Characteristic	Min	Typ	Max	Unit		
R _{thJC}	Junction to Case Thermal Resistance	IGBT		0.5	°C/W		
		Diode		1.2			
V _{ISOL}	RMS Isolation Voltage, any terminal to case t=1 min, I isol<1mA, 50/60Hz	2500			V		
T _J	Operating junction temperature range	-40		150	°C		
T _{STG}	Storage Temperature Range	-40		125			
T _C	Operating Case Temperature	-40		100			
Torque	Mounting torque		To heatsink	M4	2.5	4.7	N.m
Wt	Package Weight					110	g

SP3 Package outline (dimensions in mm)



See application note 1901 - Mounting Instructions for SP3 Power Modules on www.microsemi.com

Typical Performance Curve

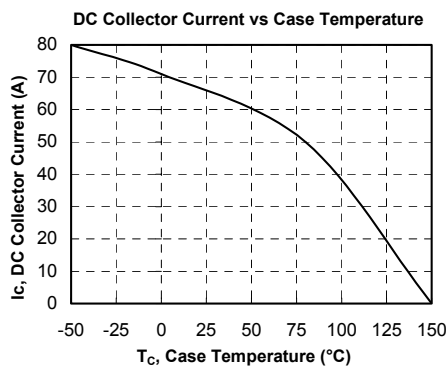
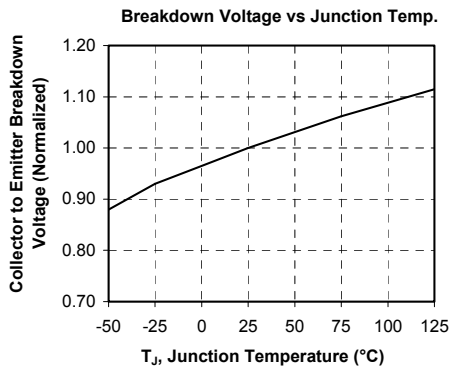
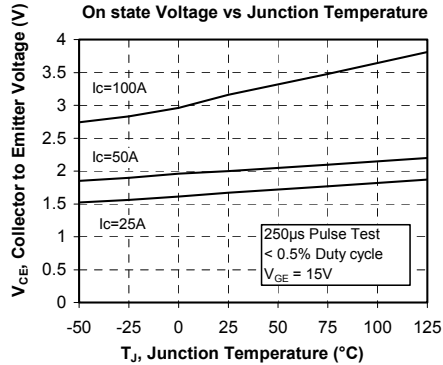
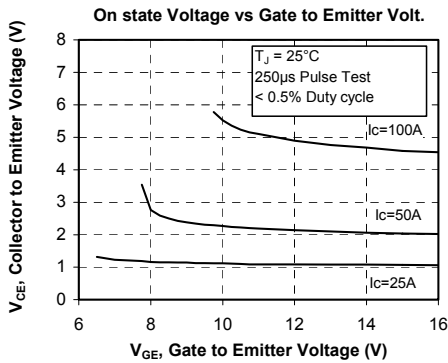
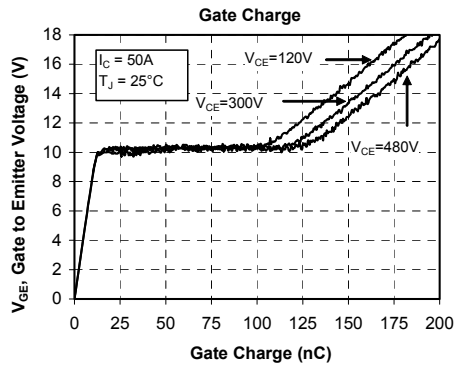
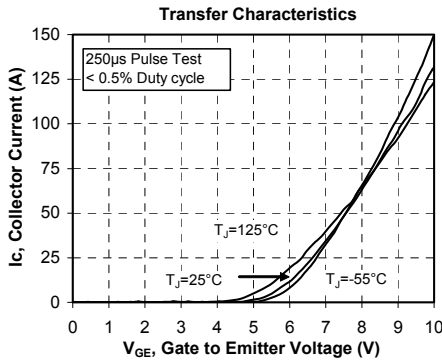
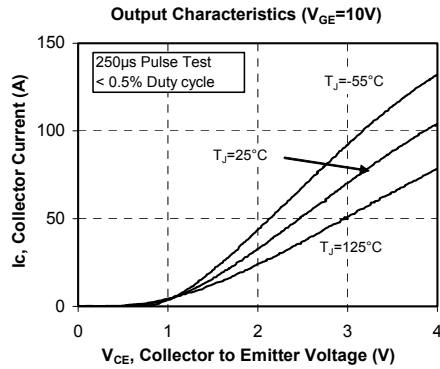
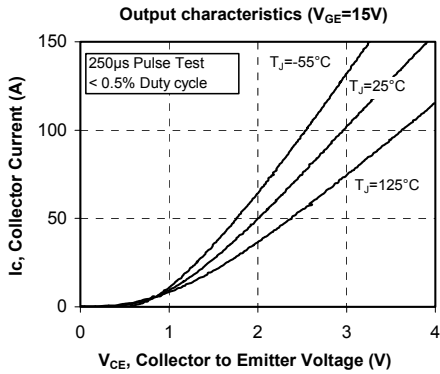

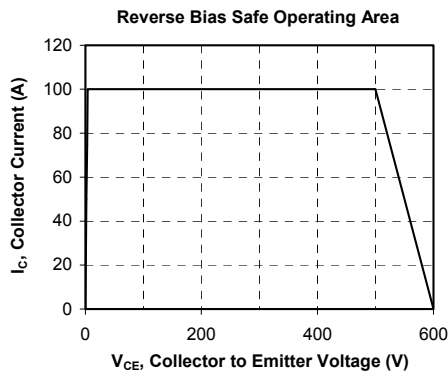
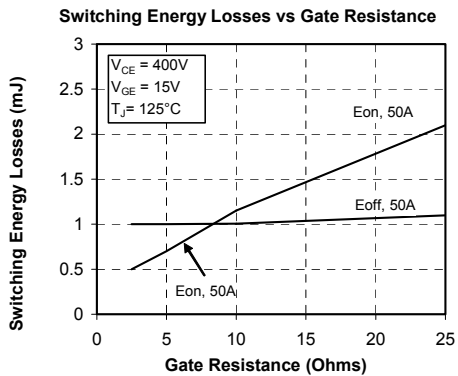
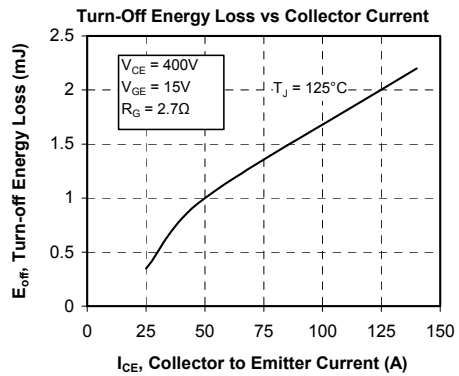
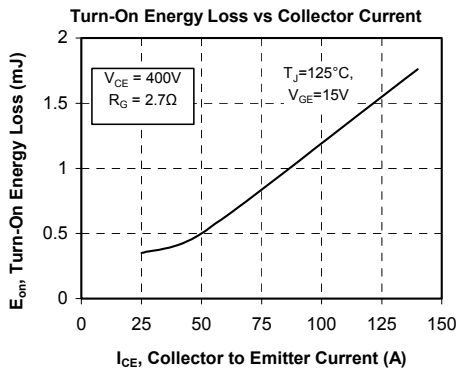
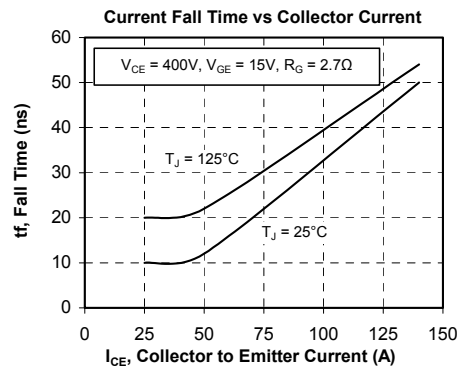
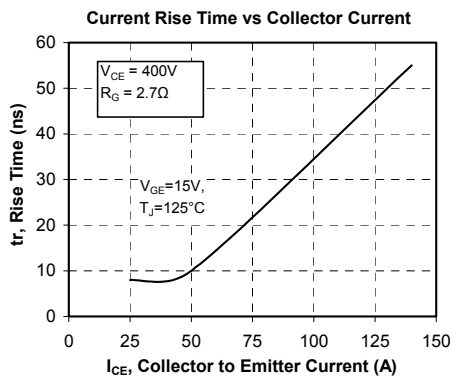
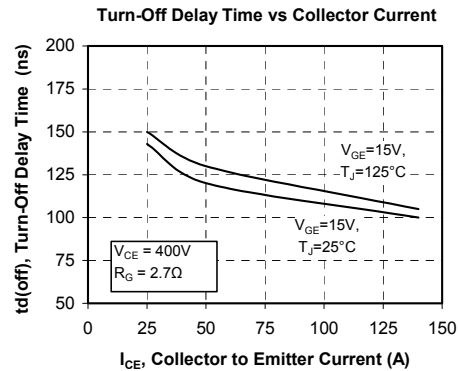
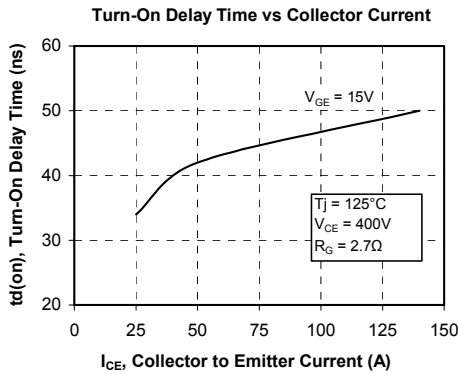

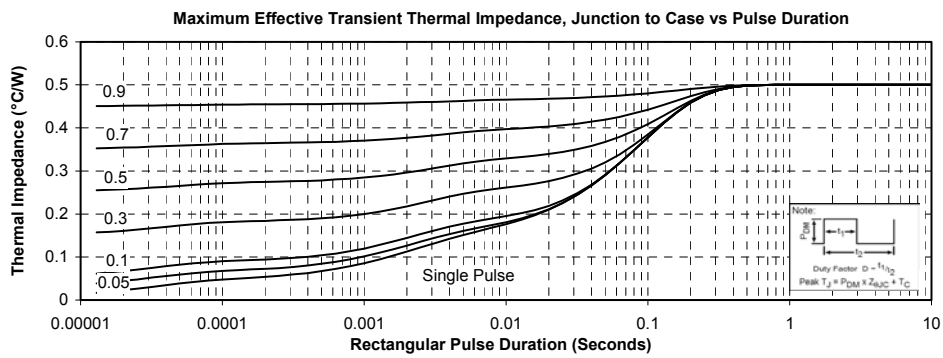
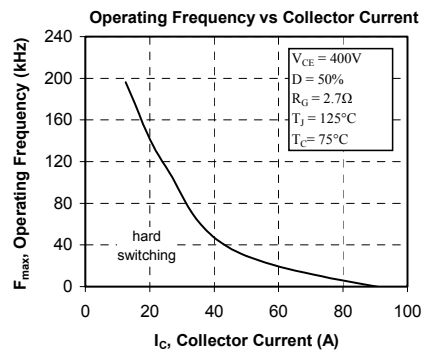
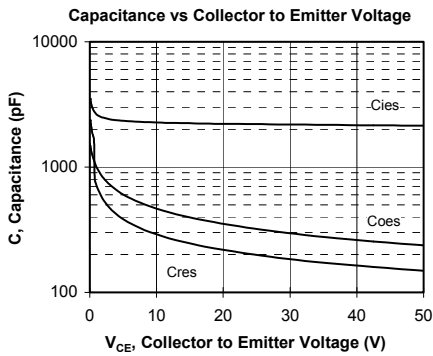

Microsemi reserves the right to change, without notice, the specifications and information contained herein

Microsemi's products are covered by one or more of U.S. patents 4,895,810 5,045,903 5,089,434 5,182,234 5,019,522 5,262,336 6,503,786 5,256,583 4,748,103 5,283,202 5,231,474 5,434,095 5,528,058 and foreign patents. U.S. and Foreign patents pending. All Rights Reserved.